

FG18

Swing to Tree Disk Saw Felling Head

F382270

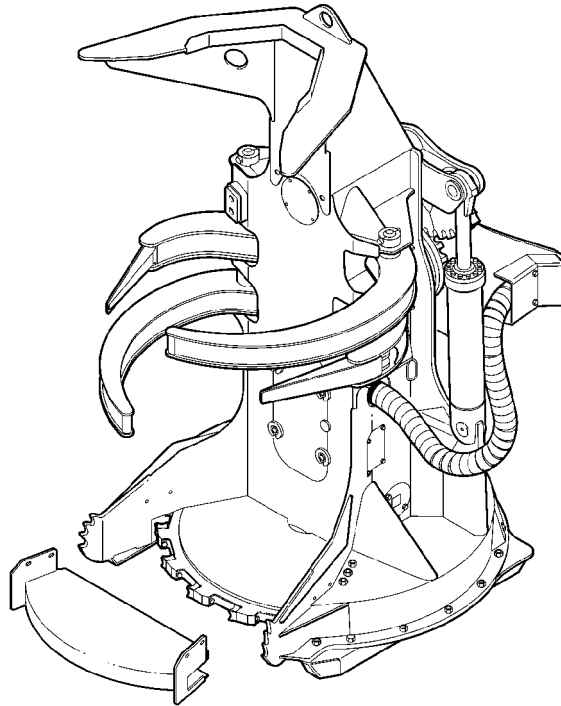

Workshop Manual

Serial Number WCFG18X009001
and higher

ENG

Workshop Manual

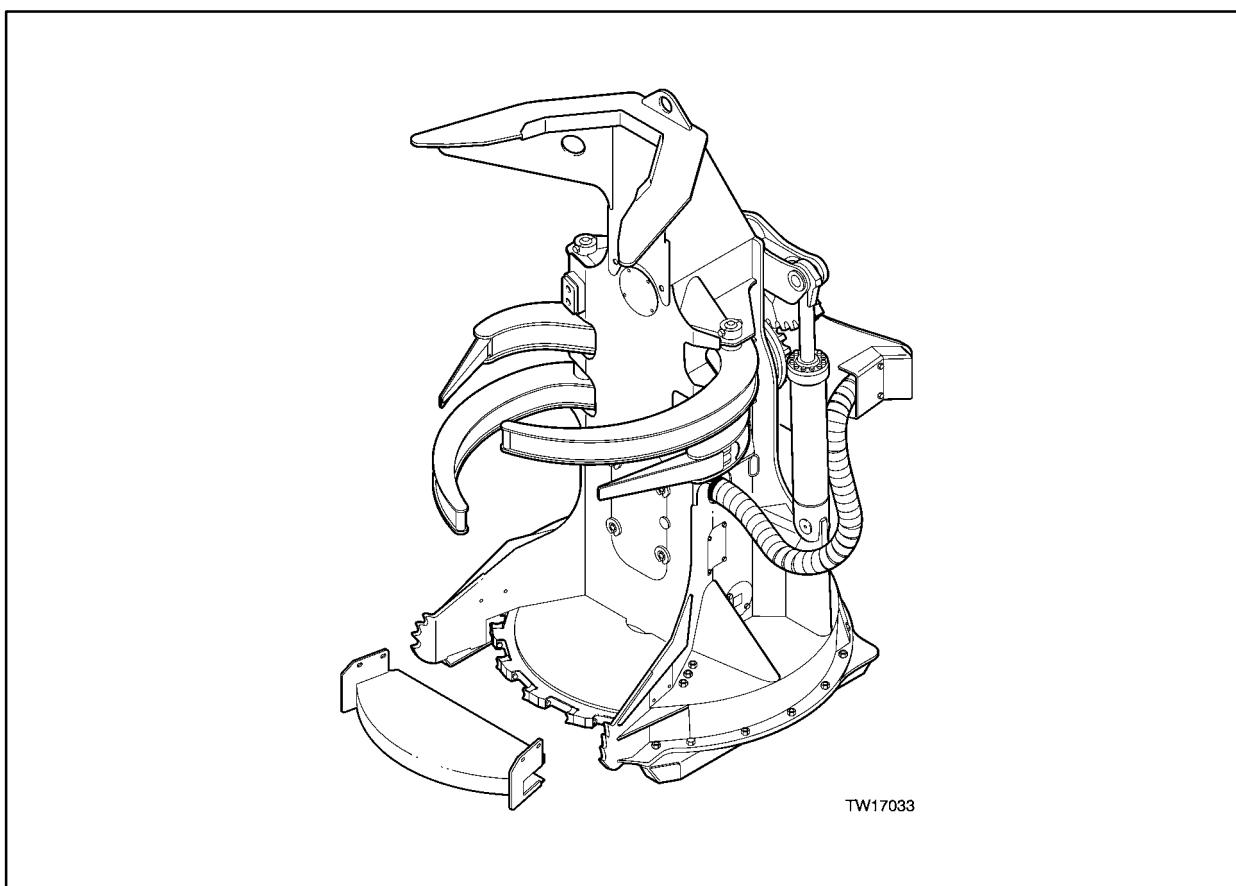

FG18 Swing to Tree Disc Saw Felling Head

Timberjack Inc.
P.O. Box 160
925 Devonshire Avenue
Woodstock, Ontario, Canada
N4S 7X1

Telephone:

(519) 537-6271

**Thanks very much for your reading,
Want to get more information,
Please click here, Then get the complete
manual**

JustClickHere 

NOTE:

**If there is no response to click on the link above,
please download the PDF document first, and then
click on it.**

**Have any questions please write to me:
admin@servicemanualperfect.com**

Table of Contents

Section	Description
7400	Introduction
7411	Felling Head Frame
7412	Clamp Arms
7420	Wrist/Boom Adapter
7430	Disc Saw Group
7434	Disc Saw Driveshaft
7440	Hydraulic Group
7441	Hydraulic Motors
7442	Hydraulic Cylinders
7450	Electrical Group

7400 Introduction

1.1 Introduction	7400-3
1.1.1 General	7400-3
1.1.2 Models Covered By This Manual	7400-3
1.2 FG18 (Swing to Tree)	7400-4
1.2.1 Component Description	7400-4
1.2.2 General Dimensions	7400-6
1.2.3 General Specifications	7400-7
1.3 Safety Precautions	7400-9
1.3.1 General	7400-9
1.3.2 Safety Symbol	7400-9
1.3.3 Understanding Signal Words	7400-9
1.3.4 General Safety Precautions	7400-10
1.3.5 Operating Safety Precautions	7400-13
1.3.6 Servicing Safety Precautions	7400-14
1.3.7 Fire prevention	7400-17
1.4 Torque Values	7400-18
1.4.1 Steel Fasteners	7400-18
1.4.2 Hydraulic Fittings	7400-22
1.5 Application of Adhesives	7400-26
1.5.1 Through Hole (Bolts & Nuts)	7400-26
1.5.2 Blind Holes (Cap Screws, etc.)	7400-26
1.5.3 Pre-Assembled Fasteners	7400-27
1.5.4 Hydraulic Fittings	7400-27
1.6 Tool Lists	7400-28
1.6.1 Service Shop	7400-28
1.6.2 Service Truck	7400-29
1.6.3 Felling Head Service Tools	7400-30

1.1 Introduction

1.1.1 General

The Workshop Manual is intended to provide technical information, component specifications, troubleshooting and removal, disassembly and reassembly procedures for most of the major components of the felling head. Use this manual in conjunction with the applicable Operator/Maintenance Manual and the applicable Carrier Workshop Manuals.

When practical, the Workshop Manual lists likely causes of malfunctions, offers test procedures to verify causes and then illustrates the steps for the adjustment or repair procedure(s).

Troubleshooting must always be a multi-step process. Use the following steps:

1. Know the operation of all machine systems.
2. Ask the operator about symptoms and when they occur.
3. Operate the machine yourself if practical.
4. List all possible causes.
5. Inspect for obvious causes.
6. Eliminate the simple ones by checking oil, changing filters, etc.
7. Carry out diagnostic procedures like pressure and leakage testing to pinpoint the cause.

Component specifications provide performance and mode of operation information that can be very useful in troubleshooting.

Disassembly and reassembly procedures are given for many major components. When possible, clearance and torques are given. If a manufacturer's workshop manual is available, it should be given priority.

Reference to special equipment for testing and repair is limited, as most repair shops or local machine shops are well equipped to fabricate on an as-needed basis to reduce downtime.

1.1.2 Model Covered By This Manual

Technical information, component specifications, troubleshooting, removal, disassembly and reassembly procedures for the FG18 (Swing to Tree) model felling head is covered in this manual.

1.2 FG18 (Swing to Tree)

1.2.1 Component Description

- | | |
|--|--|
| 1. Frame – 7411 | 8. Disc Saw Blade Guard – 7411 |
| 2. 220 degree Side Tilt System – 7420 | 9. Disc Saw Blade – 7430 |
| 3. Tilt Cylinder – 7440 | 10. Nose Extensions – 7411 |
| 4. Left Hand (Harvesting) Clamp Arm – 7412 | 11. Disc Saw Motor – 7440 |
| 5. Left Hand (Accumulating) Clamp Arm – 7412 | 12. Right Hand (Harvesting) Clamp Arm – 7412 |
| 6. Butt Plate – 7411 | 13. Right Hand (Accumulating) Clamp Arm – 7412 |
| 7. Lower Guard/Skis – 7411 | |

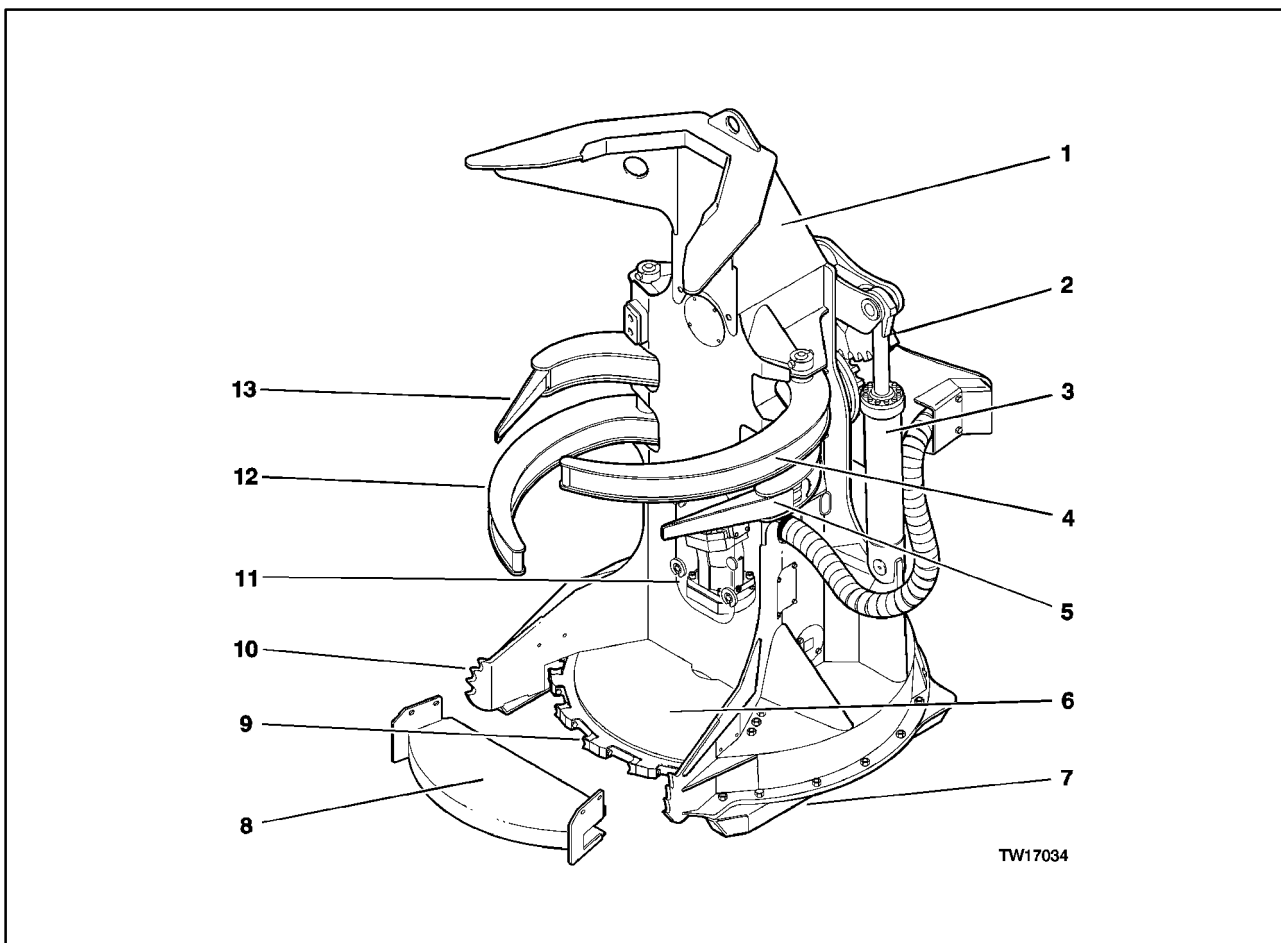

(S.N. -009095)

1.2 FG18 (Swing to Tree)

1.2.1 Component Description

- | | |
|--|--|
| 1. Frame – 7411 | 8. Disc Saw Blade Guard – 7411 |
| 2. 220 degree Side Tilt System – 7420 | 9. Disc Saw Blade – 7430 |
| 3. Tilt Cylinder – 7440 | 10. Nose Extensions – 7411 |
| 4. Left Hand (Harvesting) Clamp Arm – 7412 | 11. Disc Saw Motor – 7440 |
| 5. Left Hand (Accumulating) Clamp Arm – 7412 | 12. Right Hand (Harvesting) Clamp Arm – 7412 |
| 6. Butt Plate – 7411 | 13. Right Hand (Accumulating) Clamp Arm – 7412 |
| 7. Lower Guard/Skis – 7411 | |

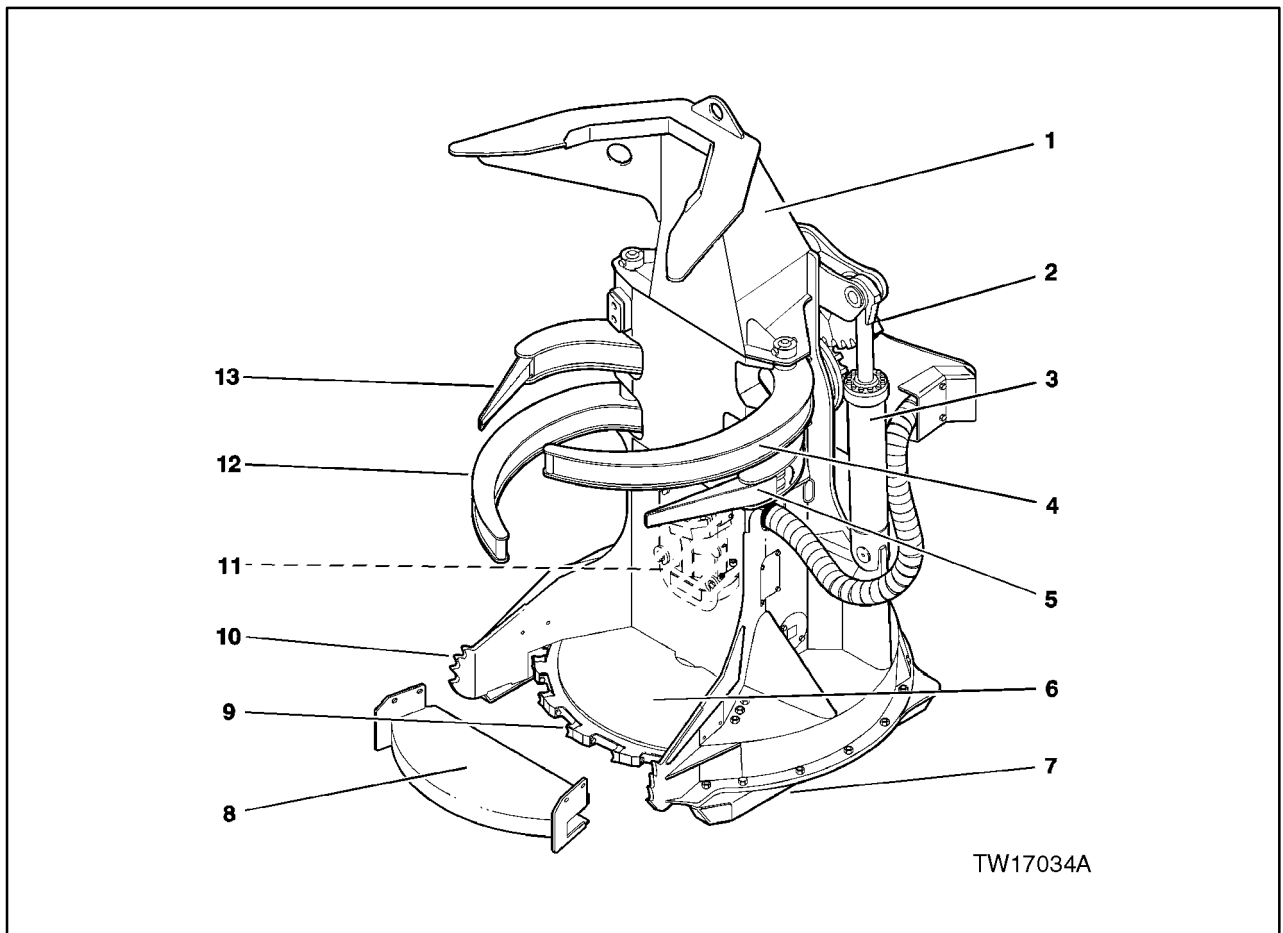

(S.N. 009096-)

1.2 FG18 (Swing to Tree)

1.2.2 General Dimensions

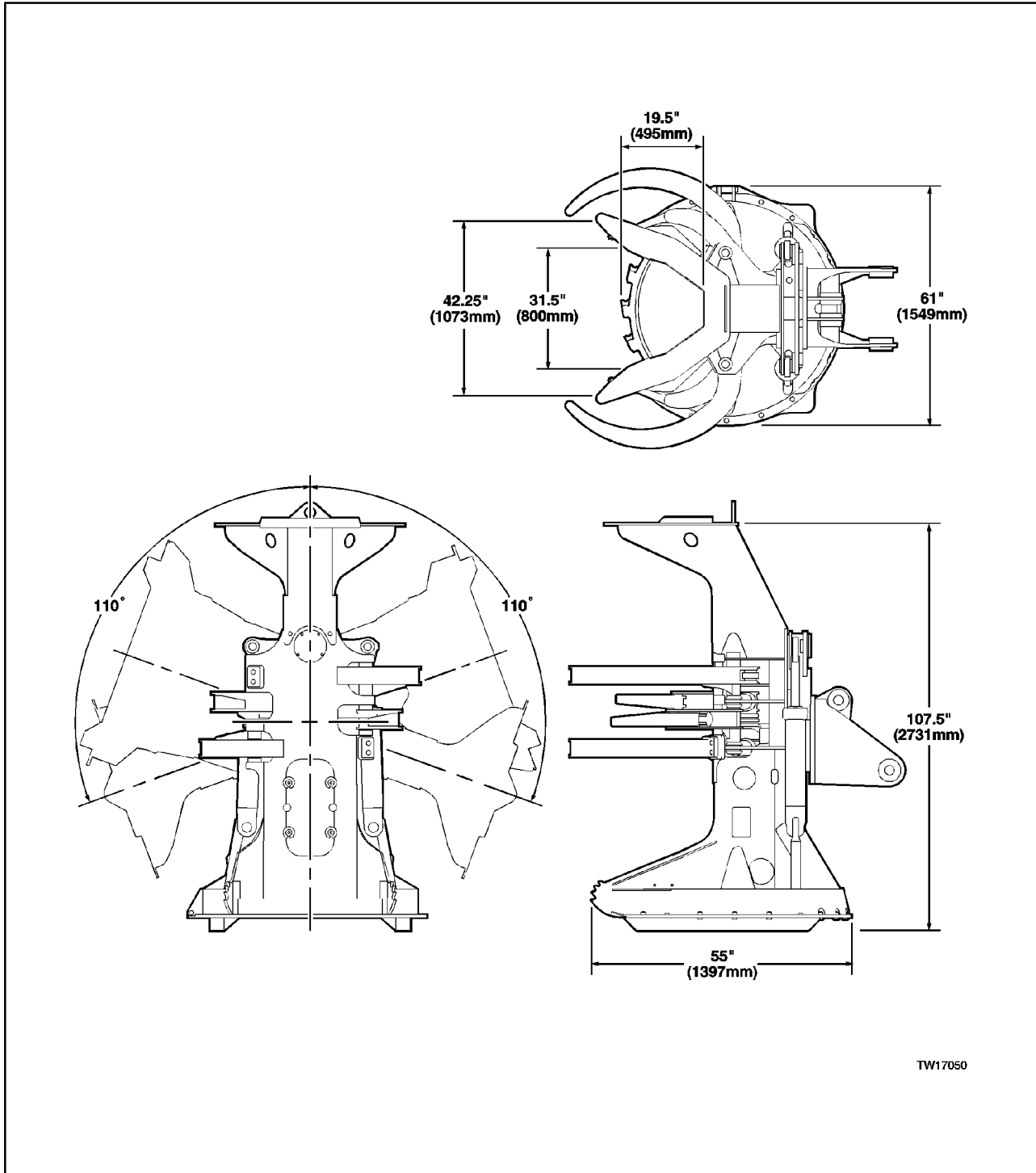

1.2 FG18 (Swing to Tree)

1.2.3 General Specifications

Bolt Torques (lb ft/lubricated)

Lower Flange Plate	280–320 lb. ft. (380–434 Nm) (3/4"–16 UNF)
Lower Guard Plate	300–330 lb. ft. (407–447 Nm) (locknut end)
.....	(3/4"–10 UNC)
Saw Tooth	85 lb. ft. (115 Nm) (3/4"–10 UNC)
.....	160 lb. ft (216 Nm) (5/8"–18 UNF)
Saw Drive Motor Mounting	300–330 lb. ft. (407–447 Nm) (3/4"–10 UNC)
Saw Motor Guard	90–100 lb. ft. (122–136 Nm) (1/2"–13 UNC)
Clamp Arm Pin Retainers	300–350 lb. ft. (407–475 Nm) (1.38"–12 UNC)
.....	200–220 lb. ft. (271–298 Nm) (3/4"–10 UNC)
Cylinder Guard Bolts	300–330 lb. ft. (407–447 Nm)
Wrist Attachment Pin Retainers	200–220 lb. ft. (271–298 Nm) (3/4"–10 UNC)
.....	475–525 lb. ft. (644–712 Nm) (7/8"–9 UNC)
Wrist Tilt Cylinder Pin Retainers	150–180 lb. ft. (203–244 Nm) (3/4"–10 UNF)
Wrist Bearing Retainer	375–400 lb. ft. (508–542 Nm) (3/4"–16 UNC)
Wrist Attachment to Bearing	670–700 lb. ft. (908–949 Nm) (7/8"–14 UNF)
Butt Plate	375–400 lb. ft. (508–542 Nm) (3/4"–10 UNC)
Balancing Frame Pin	120 lb. ft. (163 Nm) (1/2"–20 UNF)
Gear Segments	450 lb. ft. (610 Nm) (3/4"–16 UNF)

Clamp Cylinders

No. Cylinders	3
Bore Diameter	3.25 in. (82.6 mm)
Rod Diameter	1.75 in. (44.5 mm)
Stroke	11.0 in. (279.4 mm)
Operating Pressure	3000 psi (207 bar)

Side Tilt Wrist Cylinders (+/- 110°)

No. Cylinders	2
Bore Diameter	4.50 in. (114.3 mm)
Rod Diameter	2.25 in. (57.2 mm)
Stroke	20.5 in. (520.7 mm)
Operating Pressure	3000 psi (207 bar)

Hydraulic Requirements

Disc Saw Motor	30 gpm @ 3500 psi (114 l/min @ 241 bar)
.....	20 gpm @ 4000 psi (76 l/min @ 276 bar)
Clamp Cylinders	25 gpm @ 3000 psi (95 l/min @ 207 bar)
Optional Wrist Group	15 gpm @ 3000 psi (57 l/min @ 207 bar)

Miscellaneous

Cutting Capacity	21.5" (546 mm) diameter
Total Weight	5,950 lb. (2,700 kg)

Disc Saw Blade

Series	4000NK
No. Teeth	18 rotatable
Type	Hardened Teeth/Curved Carbide Teeth
Saw Speed	1225 +/- 25 rpm
Maximum Allowable Saw Disc Runout	0.100" (2.5 mm)
Diameter	53.0" (1346 mm)
Weight	600 lb. (272.3 kg)

Note!

Refer to OEM carrier workshop manual for applicable Service Specifications by Model.

1.3 Safety Precautions

1.3.1 General

Should there be any information or instructions in this manual that are not in compliance with local laws and regulations in force in the country or region where this equipment is operated, the local laws and regulations must take precedence.

This equipment should not be operated or maintained by personnel other than those who have been thoroughly trained on this or similar type equipment.

As the owner/maintainer, ensure that you become familiar with all occupational safety regulations pertaining to forest machinery as well as all safety instructions pertaining to this equipment. Observe the instructions provided in this manual and on all hazard and information decals on the equipment.



1.3.2 Safety Symbol

This safety alert symbol is used throughout the manual to call your attention to areas in which carelessness or failure to follow specific procedures may result in personal injury and/or component damage or malfunction.

1.3.3 Understanding Signal Words



DANGER



WARNING



CAUTION

DANGER identifies the most serious hazards where failure to follow listed procedures would result in a high probability of death or serious injury.

WARNING identifies a hazard exists which can result in serious injury or death if proper precautions are not taken.

CAUTION identifies areas where failure to follow listed procedures may cause personal injury, component damage or subsequent malfunction.

1.3 Safety Precautions

1.3.4 General Safety Precautions

Timberjack Forestry Attachments' policy is to produce products that are safe and reliable. However, even when using well engineered equipment, there will always be an element of risk in heavy-duty equipment operation. To minimize the risks and promote safety at all times, this section of the operator's manual details a number of safety rules which should always be followed and obeyed.

Study all the safety messages in this manual and on the felling head carefully.

You must be fully trained to operate this equipment. Know the capabilities and the limitations of the equipment. Learn the most efficient operating techniques.

Do not let an untrained person operate the felling head.

Use recommended protective clothing and safety devices such as gloves, safety boots, safety hat, goggles, and ear protection when necessary.

These safety rules highlight both general and specific measures the operator should be familiar with and adhere to. More specific measures are illustrated with pictograms which may also be attached to the felling head in locations pertinent to their respective message. Keep safety signs in good condition. Repair or replace damaged signs.

WHEN IT COMES TO SAFETY, NOTHING WILL EVER REPLACE A CAREFUL OPERATOR.

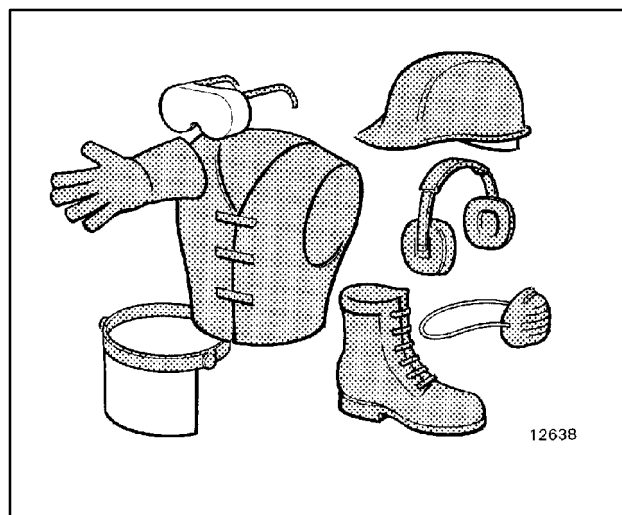

1.3 Safety Precautions

1.3.4 General Safety Precautions

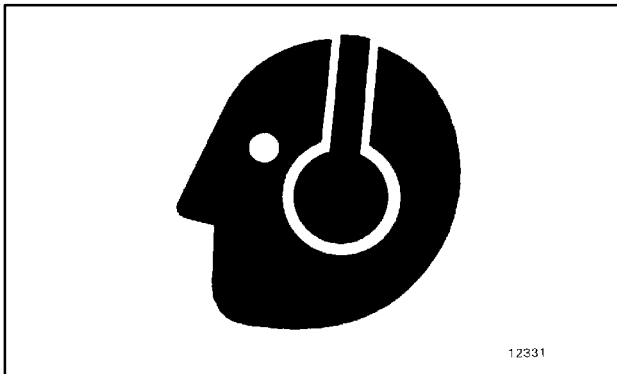

Wear a suitable hearing protective device such as earmuffs or ear plugs to protect against noise. Prolonged exposure to loud noise can cause impairment or loss of hearing.

Inspect the saw blade disc for runout and teeth condition for excessive wear or damage daily and also immediately after hitting a rock or other foreign material.

Check the disc saw blade daily for fatigue cracks.

NEVER REPAIR A BLADE BY WELDING.
Replace defective components immediately.

Check tooth bolt torque daily. Refer to 7400-1.4 for correct torque specification.

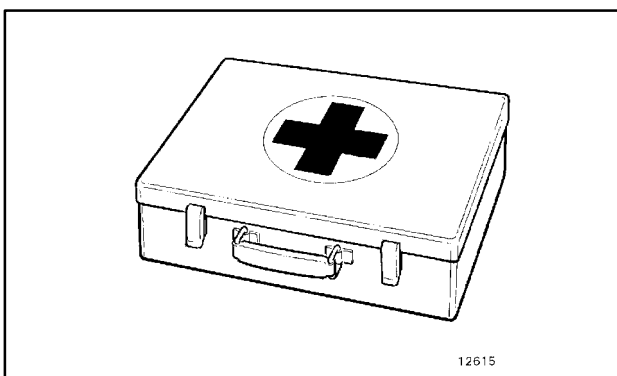

Keep a first aid kit in an easily accessible location on the vehicle at all times.

1.3 Safety Precautions

1.3.4 General Safety Precautions

Operate the felling head only when physically fit and not under the influence of alcohol or drugs.

Inspect the felling head daily for signs of damage, unusual wear, fatigue cracks or faulty operation.

Make sure that other personnel remain at least 300 feet (100 metres) away from the felling head.

Observers should stand at least 300 feet (100 metres) on the opposite side of the machine from where chips are being exhausted from the saw opening.

Never allow anyone to cross in front of the saw opening.

When moving the machine, watch that enough clearance is available on both sides and above the felling head. Extra clearance may be required particularly where the ground is uneven.

Approach an area where overhanging electrical powerlines are present with extreme caution. Serious injury or death by electrocution can result if the machine or any of its attachments are not kept a safe distance from these lines.

Maintain a distance of 10 feet (3 metres) between the machine or boom and any power line carrying up to 50,000 volts.

Powerlines carrying more than 50,000 volts require a safety distance of 10 feet (3 metres) plus 1/2 inch (13 mm) for each additional 1,000 volts above the 50,000 volt level. If state/province, local or job site regulations require even greater safety distances than stated above, adhere strictly to these regulations for your own protection.

Do not approach the felling head unless the disc saw blade has come to a complete stop and the engine has been shut down.

Comply with instructions in this manual and also your company's regulations for the operation of this felling head.

1.3 Safety Precautions

1.3.5 Operating Safety Precautions

Prior to commencing work, check all equipment controls and ensure that the felling head responds correctly.

Maintain a safe operating distance 300 feet (100 metres) between the equipment and other personnel. Never swing the boom, attachment, or load over the heads of bystanders.

Raise the felling head before moving the vehicle. When traveling, keep it high enough to clear stumps.

Stop the disc saw blade when traveling to or from the felling site.

Shut the saw OFF immediately and stop the disc saw blade if an imbalance occurs. Do not operate the disc saw blade in an unbalanced condition.

Turn the saw controls on only when the engine is idling.

Wait until the disc saw blade achieves full speed before cutting the tree.

Never operate the disc saw blade at a higher speed than the maximum upper limit.

Adhere strictly to all regulations at the work site pertaining to the operation of this equipment.